

980411

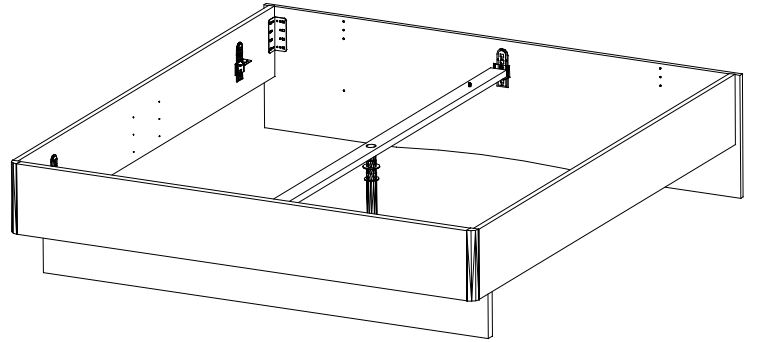

BS 260 uni

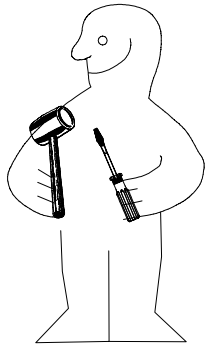
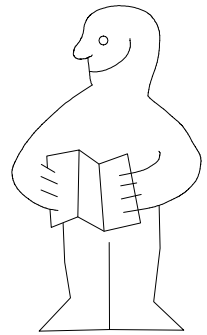
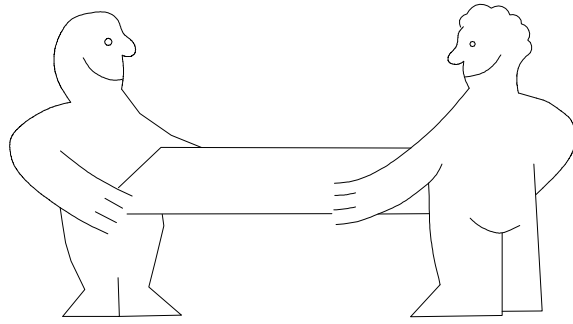
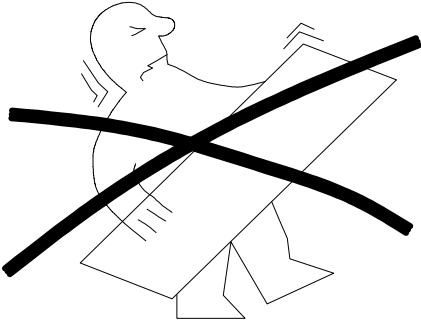

1-2-3-4...

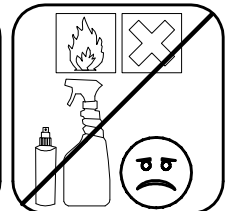
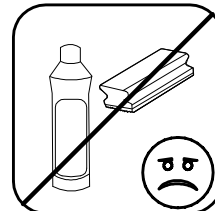
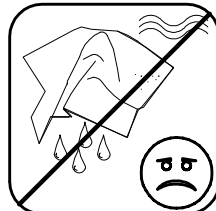
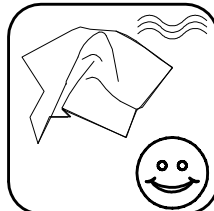
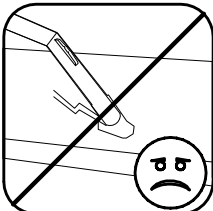
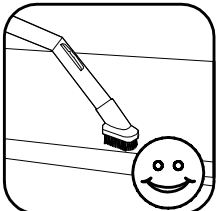
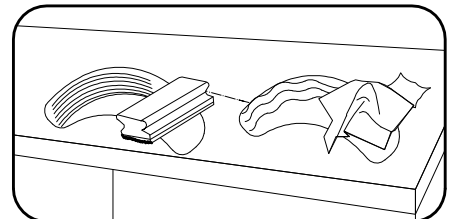
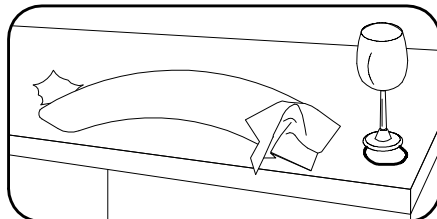
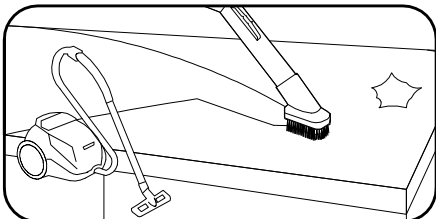
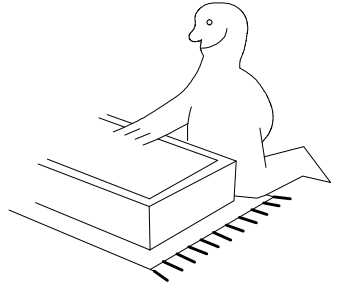
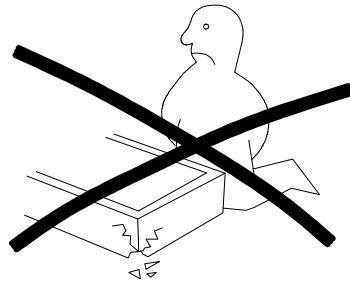
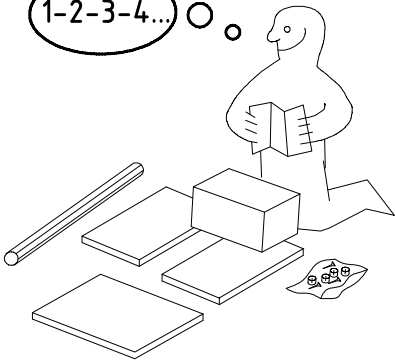

980411

17.06.16 / -

06 16

1/7

 111 135	014 4 x
 111625	09 1 x
 111 627	07 6 x
 111 626	06 6 x

 121 130	4 x 20 mm G22 16 x
 121 110	4,0 x 15 mm G23 16 x
 111634	09A 2 x
 121 121	4 x 20 mm SP20 24 x

 129 407	US 4 x
 121 150	G6 4 x
 121 149	5,0 x 35 mm G51 4 x
 121 148	6,0 x 12 mm G4 6 x

 111 112	φ 10 x 13 mm H 6 x
 111xxx	026 2 x
 121 126	SP60 4,5 x 60 mm 6 x
 353 018	D φ8 x 30 2 x

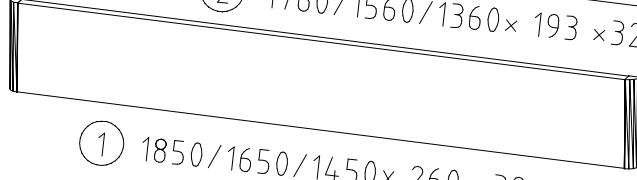
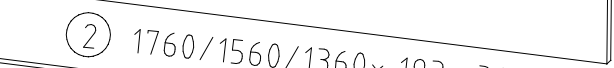
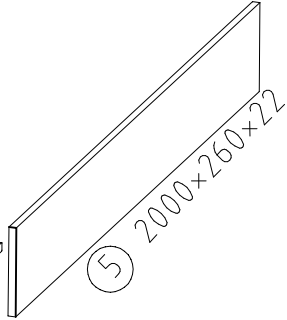
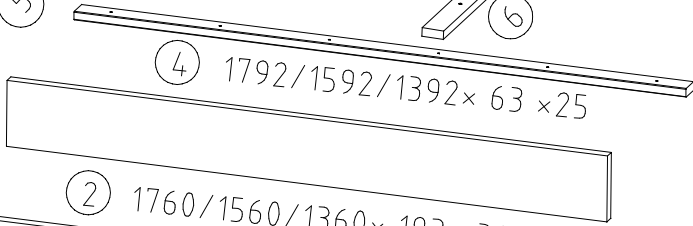
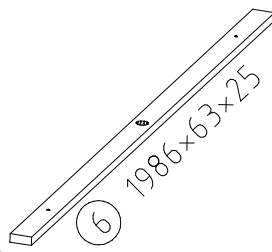
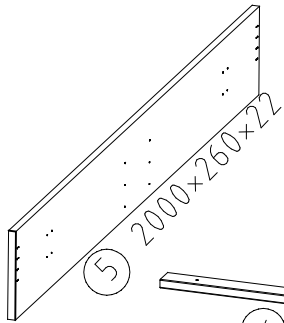
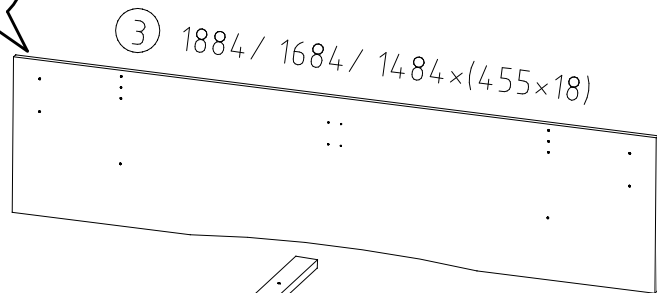
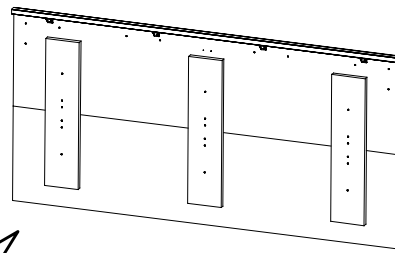
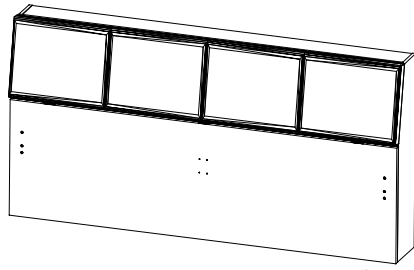
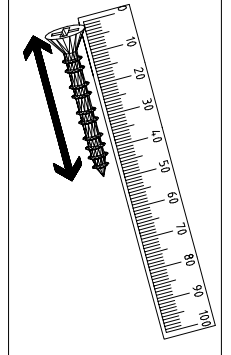
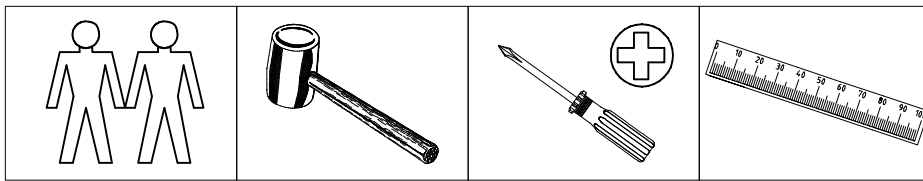
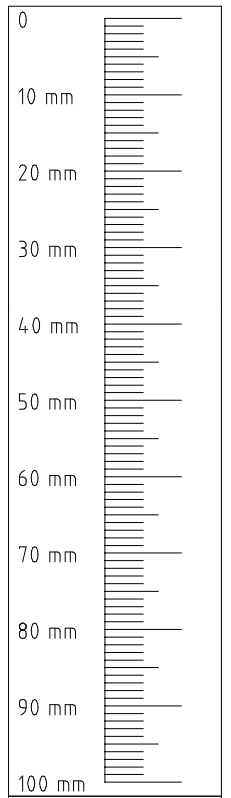

4

4,0 x 15 mm G23



121 110

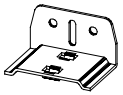

111 627

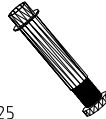

111625

o9A



111634

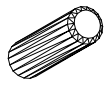

353 018

ø8 x 30

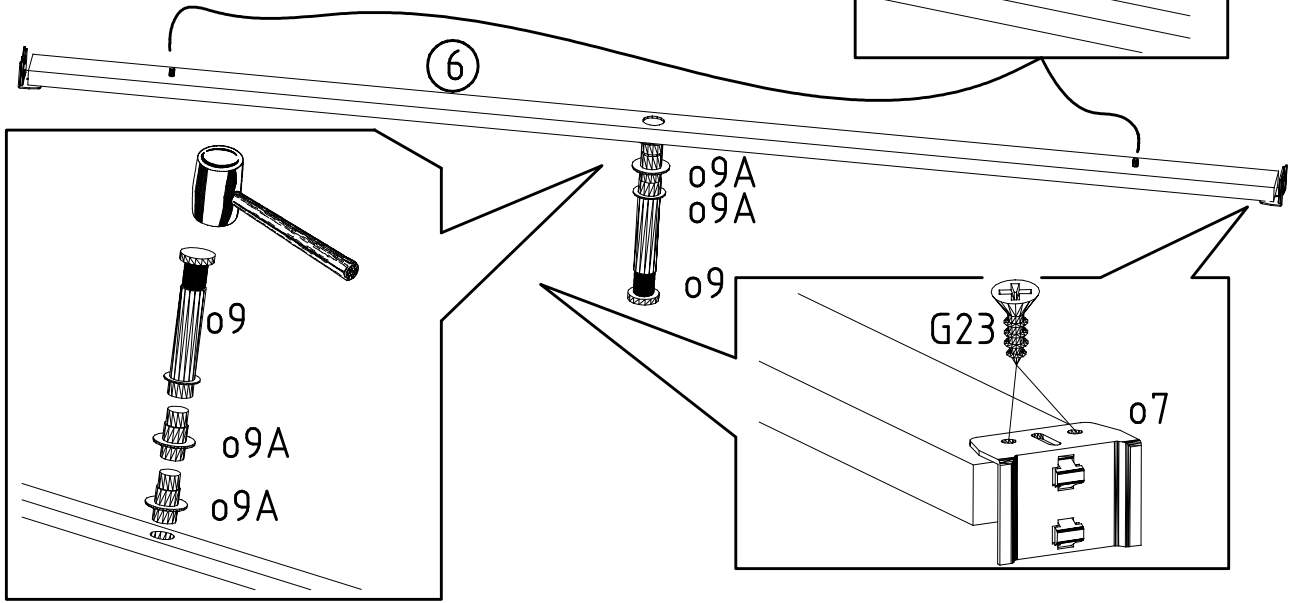

5

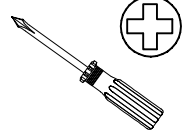
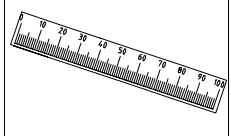
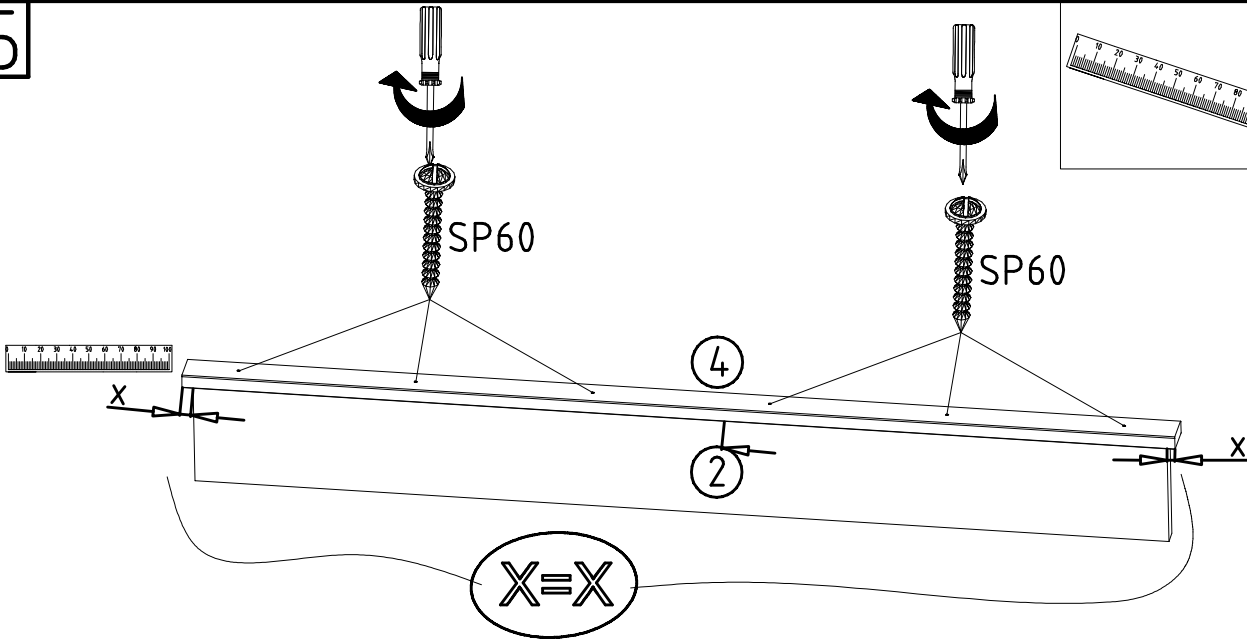

121 126 SP60

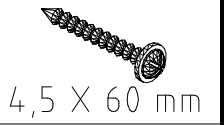

4,5 X 60 mm

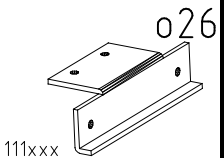
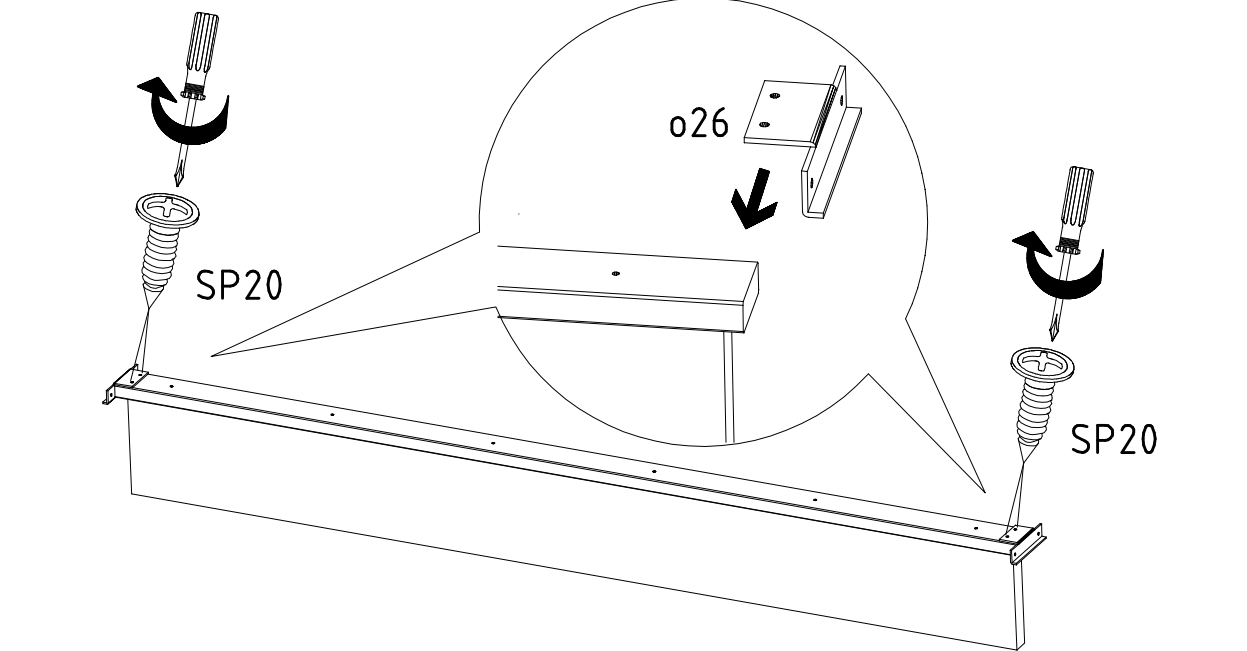

111xxx

SP20

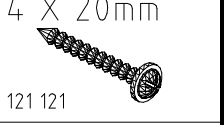

4 X 20mm

121 121

6

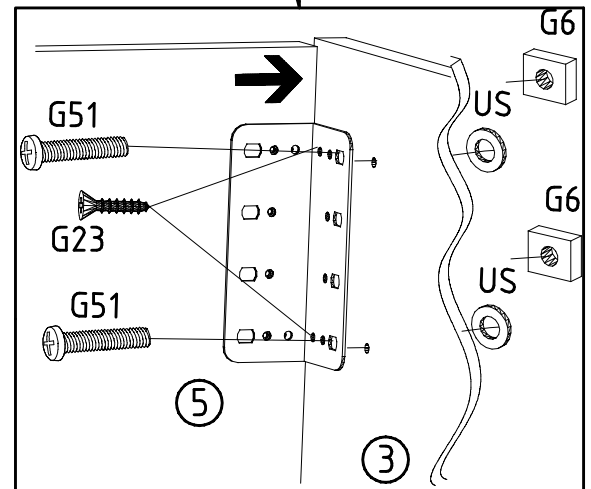
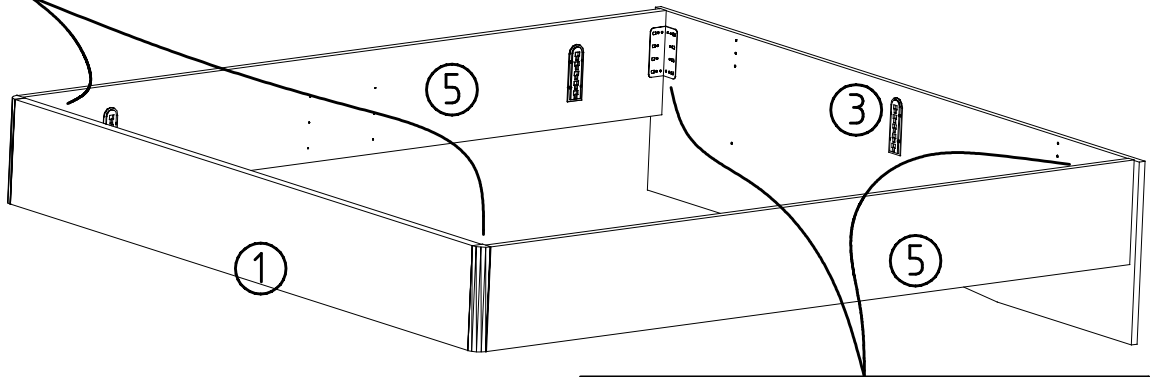
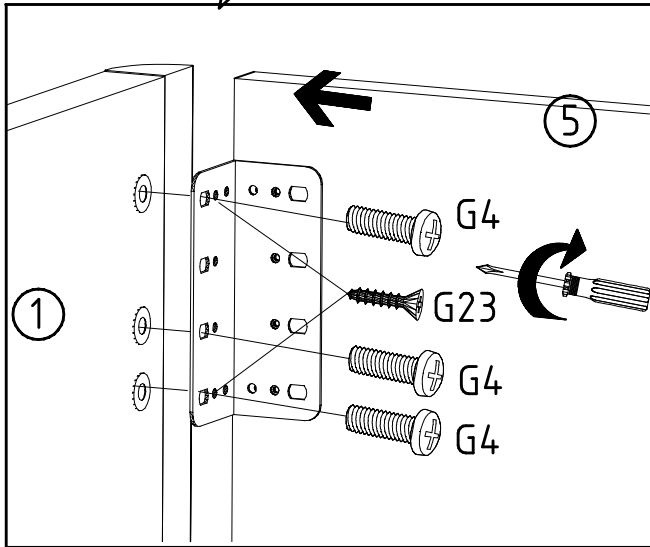
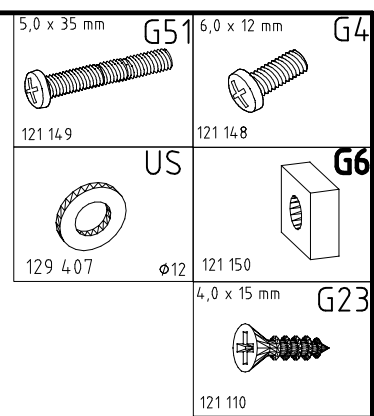
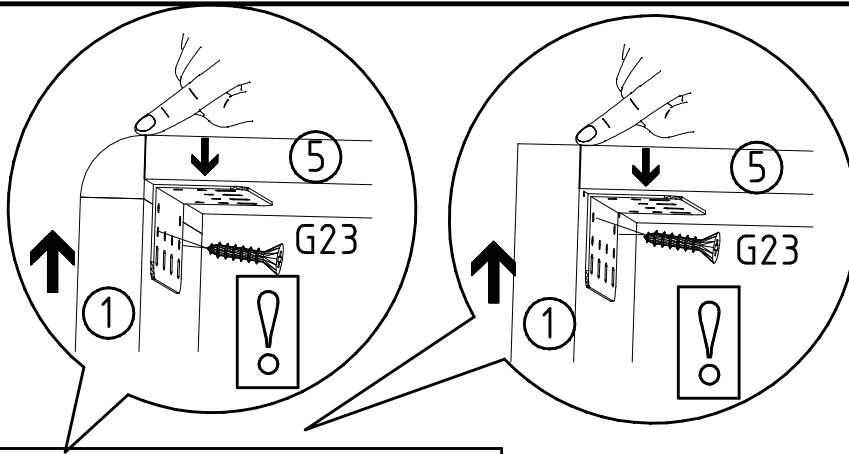

7

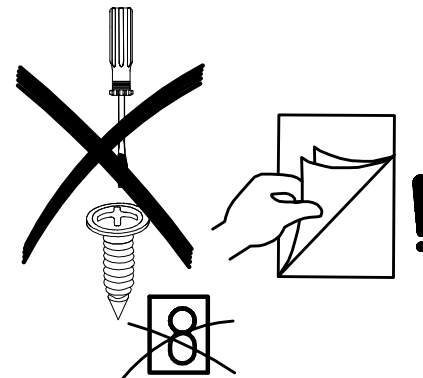
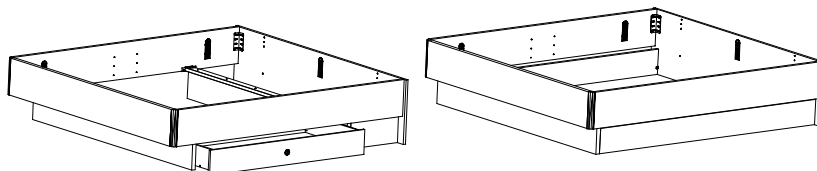
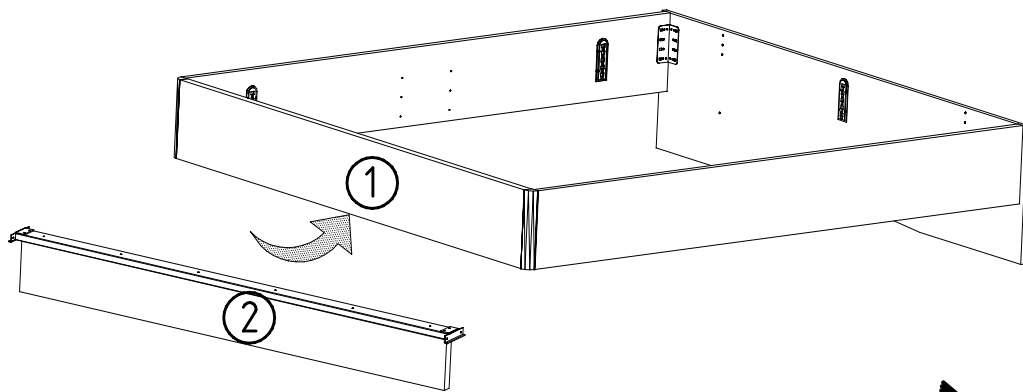

~~8~~

8

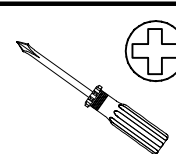
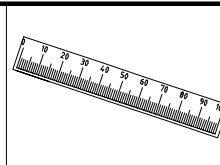
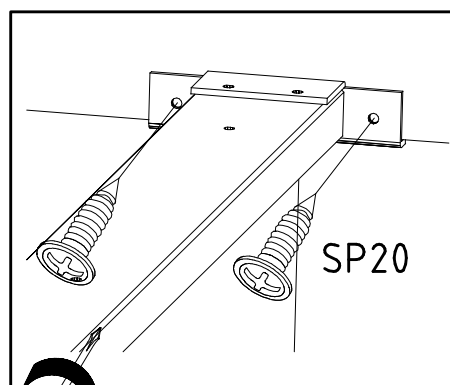

SP20
4 x 20mm
121 121

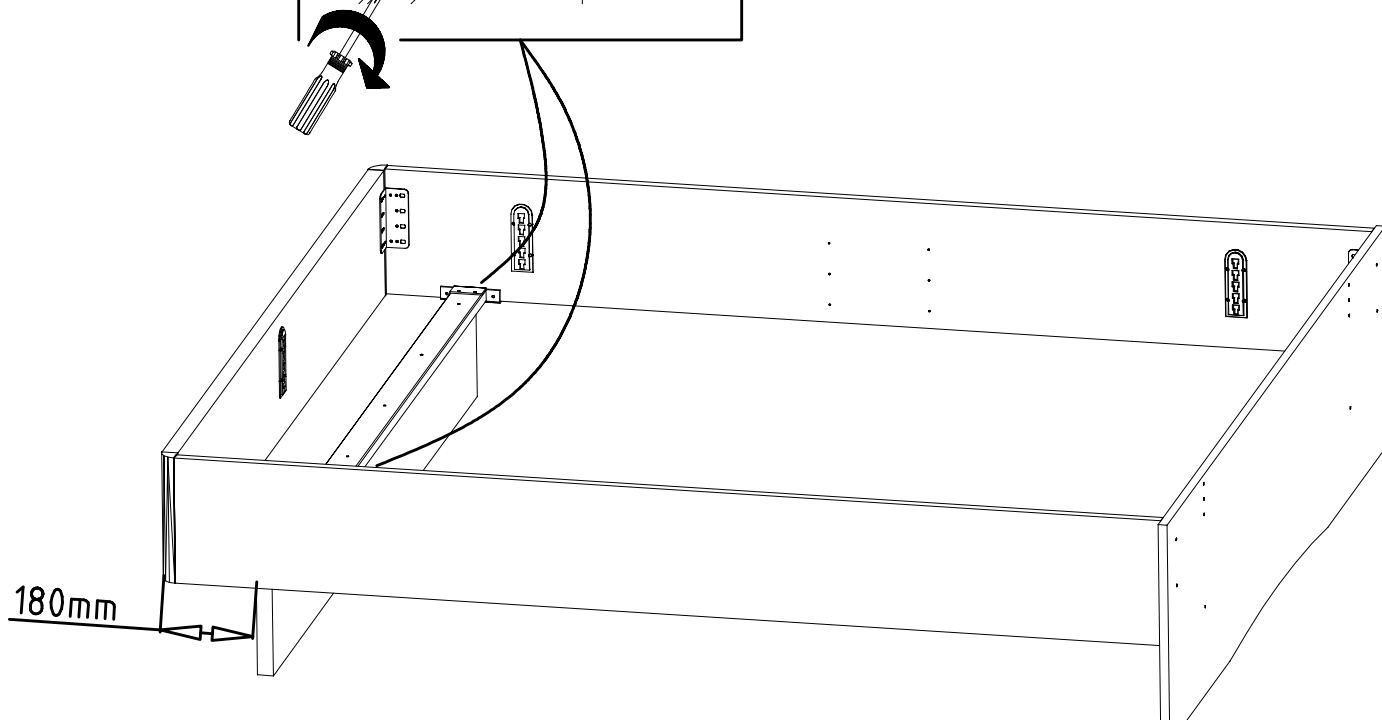

180mm

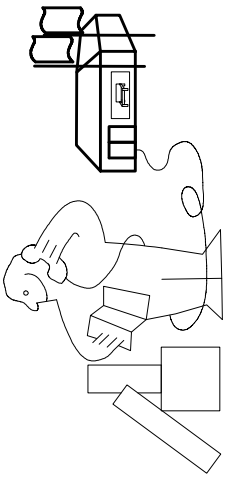
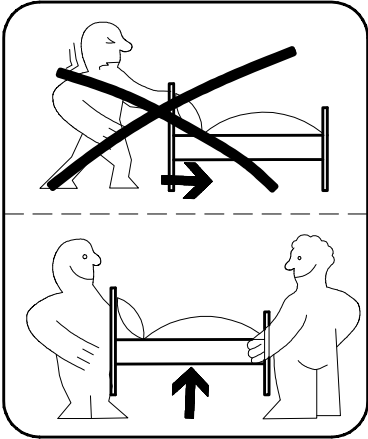
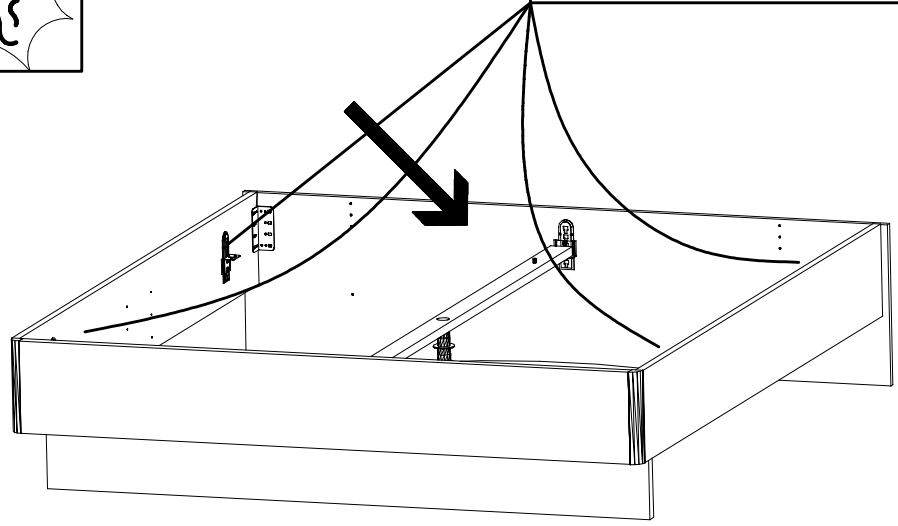
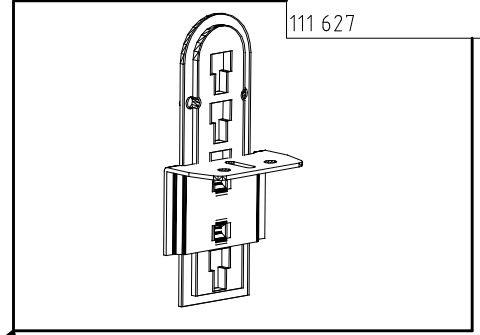
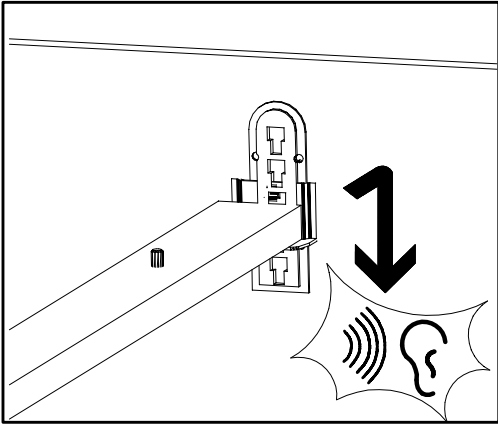
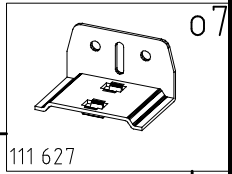

Modell/Model/Modèle

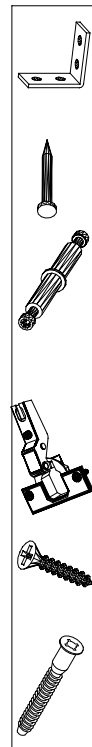
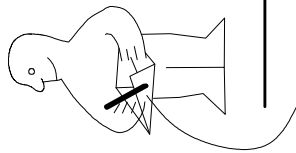
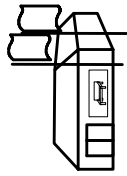
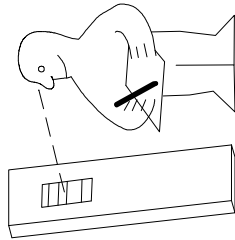

(121 370)	(G 1)	(4x)

Änderungen die dem technischen Fortschritt geschuldet sind, behalten wir uns vor!
 Bei nicht vorschriftsmäßiger und/ oder nicht fachmännischer Montage wird bei Personen- und/ oder Sachschäden keinerlei Haftung übernommen.

WIMEX Wohnbedarf/ Import Export Handels GmbH/ Postfach 1407/ 49112 Georgsmarienhütte/ Germany
 Tel.:(+49) 054-01 8598 16/17 Fax.:(+49) 054-01 8598 33 Mail: service_H@wimex-online.com

104P-NR. / 104P-NO. 150X-NR. / 150X-NO. Auftrag/Order-No. / No. de Commande

23203 **30110XY** 104

Kunde MAX MUSTERMANN
Customer
Client

Kommission / your order reference / votre reference

3377 MINDEN

Dekor / Decor Decor / Modell / Model

F99 **SAMPLE**

F99842 SCHWEBETUERENSCHRANK 250 CM H 216CM
PLANKENEICHE NB + RAH STEEL
PLANKENEICHE NACHBILDUNG

202320301107241476000001

Paket / Package / Paquet

414760

SOCKEL

Paket 1 von 8 Colli Kommission 10

HSP-SMT BOD 50 TEXT/TEX SOCKEL 32 FRESH TV / LF 104
SO-BOD TEXT RASTEX/ ZNBOD D18MM TX KLSTA

Montage - Anleitung Laenge 520,0 OBEREN
KS-64 Breite 568,0 OBEREN

SOCKEL32 KLEB

En cas de dommage, veuillez retourner le carton avec le produit. En cas de dommage, veuillez retourner le carton avec le produit.



OBEREN 5 30/19 HAUT 23.08.19 OBEREN 1 1. JABOVE OBEREN

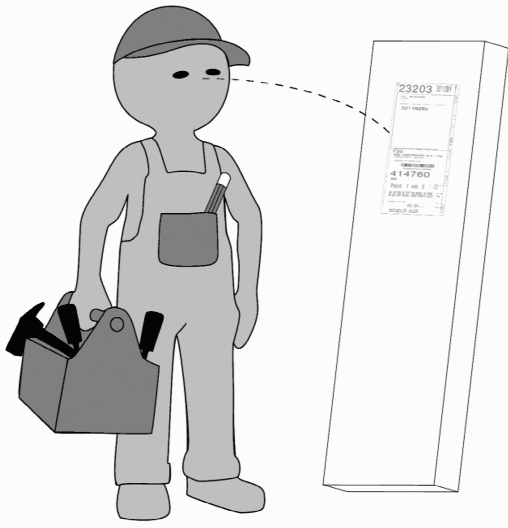

WIMEX Wohnbedarf
Import Export Handelsges mbH & Co. KG
Werner-von-Siemens-Str. 35
D-49124 Georgsmarienhütte - Germany

SAMPLE **23.08.19**
Modellname Produktionsdatum
Model Date of manufacture

